

HG808-K

Strict Environmental
Temperature and Humidity
Transmitter
Users Manual

V1.1



HENGKO Technology Co., Ltd.

About Us

HENGKO Technology Co., Ltd. is a specialized and innovative national high-tech enterprise that integrates the research and development, manufacturing, sales, and service of temperature and humidity dew point transmitters.

For over 20 years of deep cultivation in the industry, HENGKO has taken the mission of "solving the filtration, perception, and analysis problems in the gas and liquid world, making life healthier", continuously improving product performance and quality, filling the functional gap in the field of environmental measurement, solving technical problems in temperature, humidity, and dew point measurement, and helping customers continuously improve product competitiveness.

HENGKO has a team of engineers with strong independent innovation capabilities and rich industry customization experience, as well as a systematic, rigorous, and efficient product design and production system. From technical services to product development, from basic measurement to high-end applications, we provide customers with comprehensive temperature and humidity measurement solutions.

HENGKO's products are widely used in industries such as automotive manufacturing, rail transit, aviation, high-speed rail, biopharmaceuticals, gases, compressed air, electronic devices, smart agriculture, warehouses, logistics, and food processing.

Catalog

About Us	2
1. Product Introduction	5
2. Technical Parameter	10
3. Product Selection	13
4. Probe	14
5. Wiring	18
6. Instrument operation	22
7. Analog output calculation	26
8. Heat anti-condensation	29
9. Communication Protocols	30
10. Maintenance and Troubleshooting	40
11. Testing Software Download link:	43
12. Note	44
Safety and warnings	45
Contact Us	46

1. Product Introduction

1.1. Product Overview

HG808-K series harsh environment temperature and humidity transmitter has long-term stable high-precision humidity sensing ability and excellent corrosion resistance. It is equipped with a sturdy cast aluminum housing and stainless steel sensor components, suitable for continuously and accurately detecting temperature and humidity in extremely harsh high temperature (<190 °C) industrial environments.

HG808-K series harsh environment temperature and humidity transmitter is equipped with an ultra-high temperature resistant humidity sensor, which can measure temperature and humidity in working environments below 190 °C. Therefore, it is more suitable for precise measurement of temperature and humidity in various ultra-high temperature environments such as high-temperature process engineering, industrial high-temperature drying, combustion flue gas emissions, chimney emissions, and high-temperature constant temperature and humidity test chambers.

HG808-K series harsh environment temperature and humidity transmitter has excellent measurement

performance in high humidity conditions. Its high precision, durability, reliability, and sturdiness make it widely used in many aspects of the food processing industry, such as temperature and humidity monitoring and control during baking, ripening, drying, and storage of tea, corn, beans, meat, fruits, and vegetables.

HG808-K series harsh environment temperature and humidity transmitter has strong corrosion resistance and is not affected by most chemical gases such as oil vapor, dust, and micro particles. This series is not only suitable for temperature and humidity monitoring in ultra-high temperature (<190 °C) conditions, but also for measuring the temperature and humidity of gases that are prone to corrosive damage to equipment, such as exhaust gas emissions from the petrochemical industry and recycled gases from catalytic reaction reforming units in refineries. Therefore, this series of products is usually used in working environments such as high-temperature drying, equipment, process and factory automation, clean rooms, pharmaceutical industry, chemical industry, refinery equipment, etc.

HG808-K series harsh environment temperature and humidity transmitter has multiple types of probes to choose from. Please refer to Article 4 "Probe " for details.

1.2. Product Overview

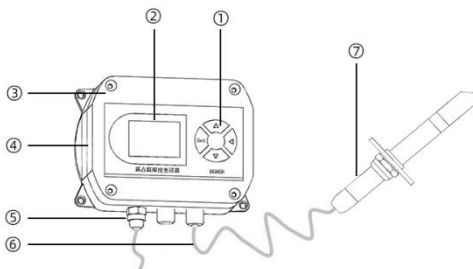
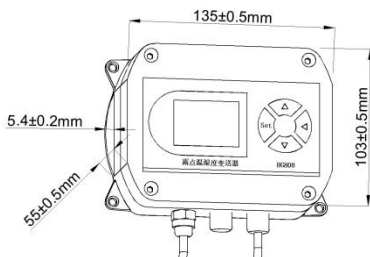

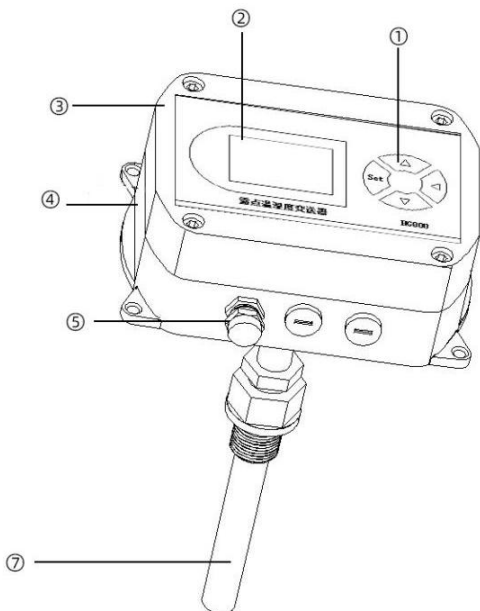

1=Keys

2=LCD display screen

3=Aluminum alloy upper cover

4=Aluminum alloy lower cover

5=Sensor power cable

6=Sensor probe input cable

7=Sensor probe (stainless steel)

1.3. Function Features

- Split/pipeline probe with strong anti pollution and anti oil capabilities
- Simultaneously supporting RS485 output and two analog outputs
- Analog 15 bit high-resolution output, digital output with optional resolution of 0.1 or 0.01
- Supports single register and multi register reading
- The product has anti condensation function, which can keep the sensor synchronized in high humidity environments
- Digital output can simultaneously read dew point, humidity, temperature, and PPM values.
- Adopting the standard Modbus RTU protocol, it can easily achieve interconnection with PLC, DCS, and various configuration software
- 10V~28V ultra wide voltage input, overcurrent protection, power polarity protection, industrial grade ESD safety protection, and power anti reverse connection function

2. Technical Parameter

2.1. Specifications

Range and Accuracy		
Temperature range	-40 ~ +190°C	see for details Measurement Value 2.2
Humidity range	0 ~ 100%RH (recommend <95%RH)	
Temperature accuracy	±0.1°C (@20°C)	
Humidity accuracy	±2%RH (@20°C, 10~90%RH)	
Input and Output		
Power supply	DC 10V ~ 28V	
Power consumption	<0.5W	
Analog Outputs	Humidity+Temperature	
	4~20mA /0-5V /0-10V (One out of three)	
RS485 Digital Output	Temperature, humidity, dew point, PPM (read simultaneously)	
	resolution ratio: 0.01°C / 0.1°C (optional) 0.01%RH / 0.1%RH (optional)	
Baud rate	1200, 2400, 4800, 9600, 19200, 115200 can be set, The default is 9600 bps	
Acquisition frequency	The fastest response is 1 second, other settings can be set according to PLC	
Byte format	8 data bits, 1 stop bit, no check	
Pressurization	16 bar	
Working temperature (Transmitter body)	- 20°C ~ +60°C, 0%RH ~ 95%RH (Non condensation)	
(Dew point value for reference only)		

2.2. Measurement values

Relative humidity

Measurement range 0~100% RH

Accuracy $\pm 2\%RH$ (@20°C, 10~90%RH)

Accuracy of the humidity

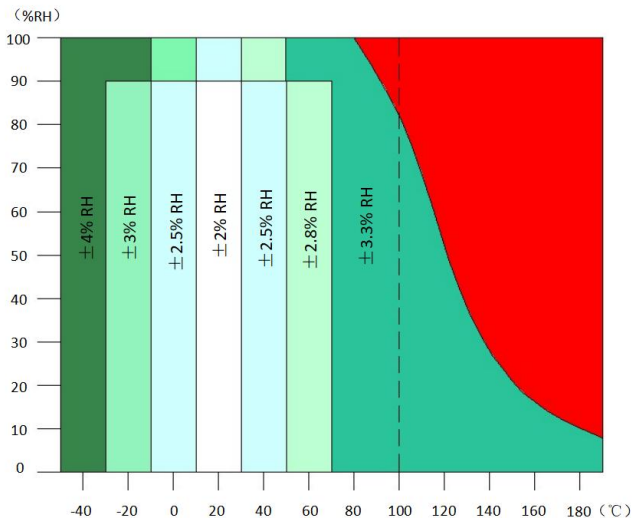

Factory calibration uncertainty (+20 °C)

$\pm 0.6\%RH$ (0~40%RH)

$\pm 1.0\%RH$ (40~97%RH)

(Defined as ± 2 standard deviation limit. There may be slight fluctuations)

Temperature

Measurement range

-40 ~ +190°C

Accuracy

±0.1°C (@20°C)

Accuracy of temperature

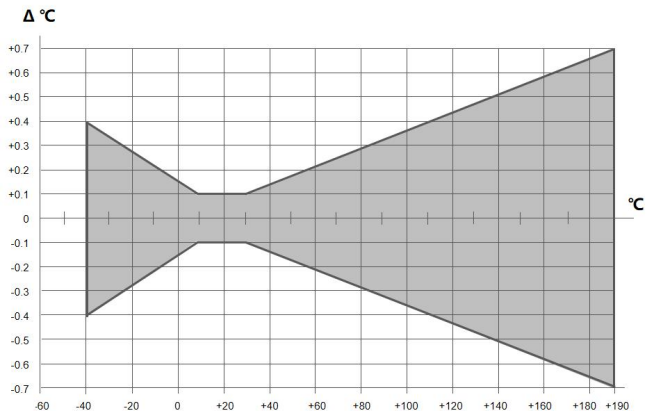

3. Product Selection

		HG808-K				
Probe Type	Split 0	Split 1	Split 3	Pipeline 5	Split 6	
	0	1	3	5	6	
Display Function	With display			Without display		
	Y			N		
Analog signal output(+485)	4~20mA		0-5V		0-10V	
	4		5		1	
Probe protection cover	Stainless steel sintering			Stainless steel grid		
	A			B		

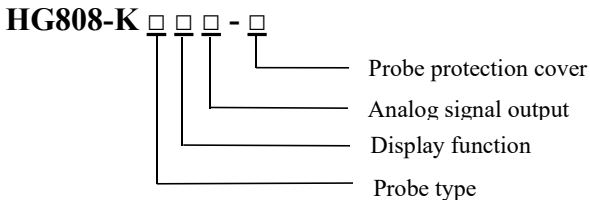



e.g:



HG808-K3Y4-A is designed for high temperature and high humidity environments, with an analog output of 4-20mA, split type probe. It uses a type 3 probe and a stainless steel sintered probe protective cover. With display.

4. Probe

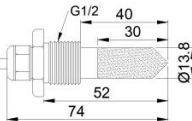
4.1. Probe Type

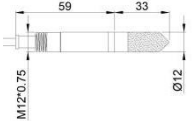

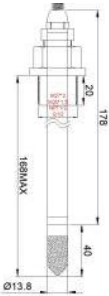
The probes of the HG808 transmitter are equipped with stainless steel sintered filters from HENGKO. The conventional probe structure is shown in the table below (customizable according to customer needs):

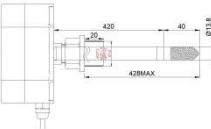
Type	Probe Description	Picture	Probe size
Split type probe 0	Compact and compact in structure, with optional hexagonal thread size, suitable for threaded fastening work environments or installation through box walls, easy to install.		
Split type probe 1	Commonly selected probes can be used in various workplaces. The sturdy and compact probe structure is particularly suitable for narrow spaces, winding pipelines, and smaller pipelines.		

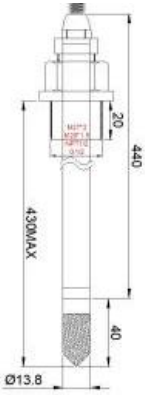
<p>Split type probe 3</p>	<p>Used for a wide pressure range, it is an ideal choice for temperature and humidity measurement processes in pressurized or vacuum environments.</p>		
<p>Pipeline probe 5</p>	<p>Featuring dust and corrosion resistance, it can be used for temperature and humidity measurement and monitoring in various industrial fields. Suitable for high-temperature pipeline facilities such as large-sized pipelines and smoke pipes, as well as machine equipment working conditions.</p>		

<p>Split type probe 6</p>	<p>Commonly used for measuring temperature and humidity in high-temperature pipeline facilities such as large-sized pipelines and smoke pipes, or in wider box spaces where the temperature near the facility is high and transmission equipment is not suitable for installation.</p>		
-----------------------------------	--	---	---

4.2. Probe protection cover:

Type	Picture	Selection instructions
Stainless steel sintering		<p>When applied in environments with high humidity, low dust, and easy condensation, grid style protective covers are more suitable.</p>
Stainless steel grid		

4.3. Probe installation

Flange Stainless steel probe	G1/2" Hexagonal threaded Stainless steel probe	NPT1/2 Hexagonal threaded Stainless steel probe	M20 * 1.5 Hexagonal threaded Stainless steel probe	M27 * 2 Hexagonal threaded Stainless steel probe
				
				
				

5. Wiring

The transmitter output adopts an 8-core cable, and the functions of each color wire core are defined as follows:

Red	Black	Yellow	Green	Grey	White	Brown	Blue
Power	GND	RS485 A	RS485 B	Humidity +	Humidity -	Temperature +	Temperature -

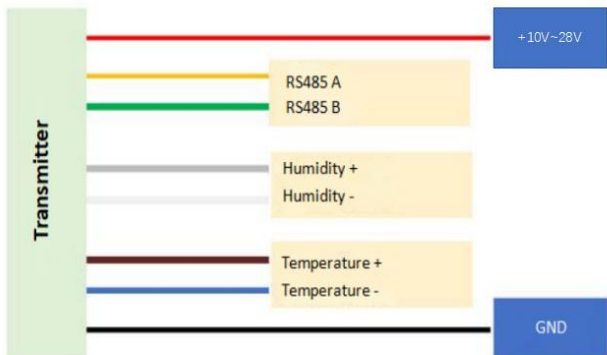

Please check the transmitter wiring to prevent damage to the transmitter due to incorrect wiring! Please wire transmitters with different analog output types according to the diagram below.

4-20mA Current Type Wiring Diagram :



Please double-check the sensor wiring before powering on to prevent damage to the sensor due to the wrong wire!

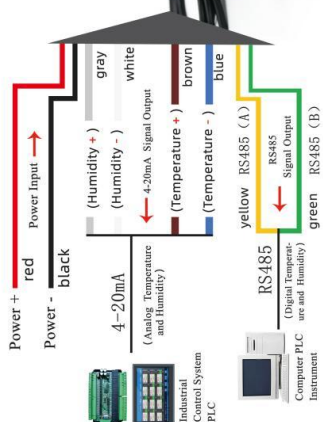

0-5V Voltage Type Wiring Diagram :



Please double-check the sensor wiring before powering on to prevent damage to the sensor due to the wrong wire!

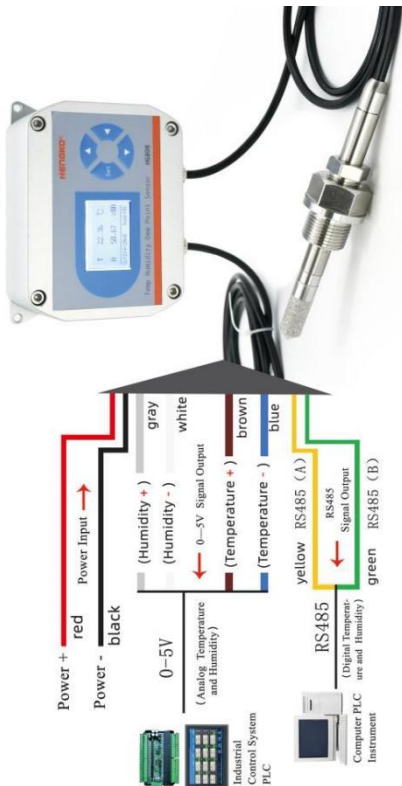

0-10V voltage type wiring diagram :



Please double-check the sensor wiring before powering on to prevent damage to the sensor due to the wrong wire!

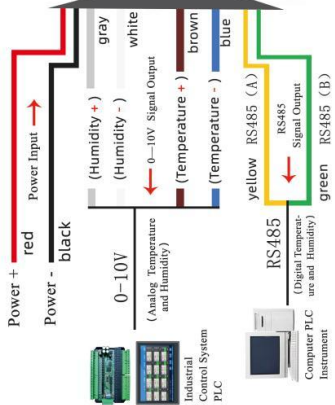

6. Instrument operation

The meter runs automatically after powering on, and when it starts, the model number of the table HG-808 will be displayed, as shown in the following figure:

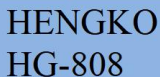

HENGKO
HG-808

<Button function>

HG-808 has 4 buttons, and the functions of each button are defined as follows:

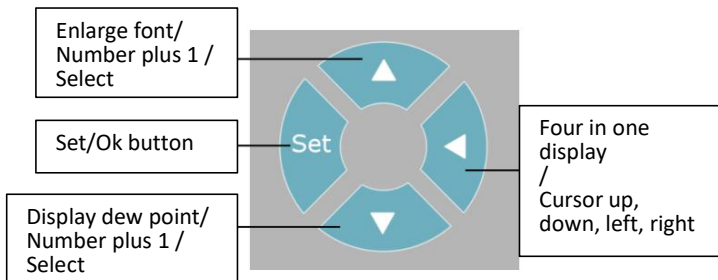



<Real-time monitoring>

Press the button  on the panel to enter the single data display mode. Temperature, humidity and dew point are displayed alternately every second, and the data is automatically refreshed.

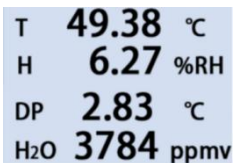

The micro water and dew point display modes are shown in the following figure. In other display modes, press the buttons  on the panel to switch to this display mode at any time.



Press the button  on the panel to switch to the simultaneous display mode of temperature, humidity, and dew point, as shown in the following figure

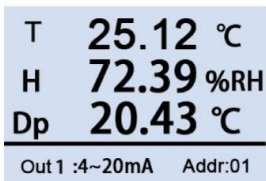

<Parameter settings>

Press the button  to display the interface that requires entering a password, as shown in the following figure:



After entering the password of “100”, press the Set button again to enter the following settings interface in sequence:

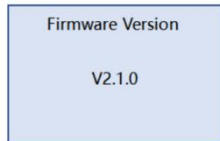
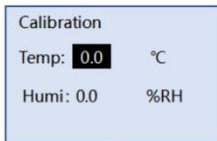
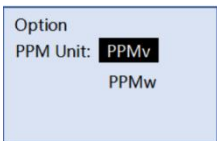
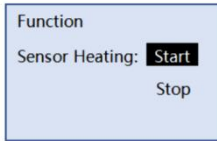
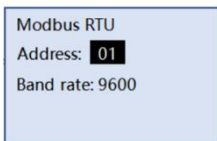
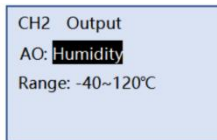
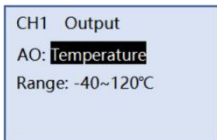

7. Analog output calculation

4-20mA current type output signal conversion calculation:

For example:

The range is $-40\sim+80^{\circ}\text{C}$, 4~20mA output, when the output signal is 12mA, the current temperature value is calculated.

The span of this temperature range is 120°C , which is expressed by a 16mA current signal, $120^{\circ}\text{C}/16\text{mA} = 7.5^{\circ}\text{C}/\text{mA}$, that is, the current 1mA represents a temperature change of 7.5°C .

$$\text{Measured value: } 12\text{mA} - 4\text{mA} = 8\text{mA},$$

$$8\text{mA} * 7.5^{\circ}\text{C}/\text{mA} = 60^{\circ}\text{C}$$

$$60 + (-40) = 20^{\circ}\text{C}$$

The current temperature is 20°C

0-5V voltage type output signal conversion calculation:

For example:

The range is $-40\sim+80^{\circ}\text{C}$, 0-5V output, when the output signal is 3V, the current temperature value is calculated.

The span of this temperature range is 120°C , which is expressed by a 5V voltage signal, $120^{\circ}\text{C}/5\text{V}=24^{\circ}\text{C}/\text{V}$, that is, the voltage 1V represents the temperature change of 24°C .

$$\text{Measured value: } 3\text{V}-0\text{V}=3\text{V}$$

$$3\text{V}\times 24^{\circ}\text{C}/\text{V}=72^{\circ}\text{C}$$

$$72 + (-40) = 32^{\circ}\text{C}$$

The current temperature is 32°C

The above calculations are generally used for debugging and analysis, and when the PLC/DCS system is actually connected, the conversion and digital display by the ADC are completed by the PLC or DCS system.

0-10V voltage type output signal conversion calculation:

For example:

Measuring range $-40\sim+80^{\circ}\text{C}$, 0-10V output, when the output signal is 5V, calculate the current temperature value.

The span of this temperature range is 120°C , which is expressed by a 10V voltage signal, $120^{\circ}\text{C}/10\text{V}=12^{\circ}\text{C}/\text{V}$, i.e. voltage 1V represents a temperature change of 12°C ,

$$\text{Measured value: } 5\text{V}-0\text{V}=5\text{V}$$

$$5\text{V}\times 12^{\circ}\text{C}/\text{V}=60^{\circ}\text{C}$$

$$60+(-40)=20^{\circ}\text{C}$$

The current temperature is 20°C

The above calculations are generally used for debugging and analysis, and when the PLC/DCS system is actually connected, the conversion and digital display by the ADC are completed by the PLC or DCS system.

8. Heat anti-condensation

➤ To enable the heating and anti-condensation function, go to the HG602&808 Test Tools program and click the button on the heating function bar<ON>.

➤ After 10 minutes of activating the heated anti-condensation function, the heated anti-condensation function will be automatically turned off.

➤ If you need to turn off the heating and anti-condensation function immediately, please go to the HG602&808 Test Tools program, click the button in the heating function bar<OFF>, and turn off the heating and anti-condensation function.

9. Communication Protocols

Communication protocol: Modbus-RTU

Default communication mode: 9600bps,n,8,1,

Address: The default value is 1

Downlink Packet Format (PLC → Instrument):

Address Code	Function	Start Address	Number of Registers	CRC-16
1byte	1byte	2byte (H,L) *	2byte (H,L)	2byte (L,H)

Uplink message format (instrument → PLC):

Address Code	Function	Data length*	Data *	CRC-16
1byte	1byte	1byte	1~N	2byte (L,H)

- * “H” is a high byte , “L” is a low byte , used to indicate the byte order
- * Data length: the number of bytes of all data,

$$\text{data length} = \text{number of registers} \times 2$$
- * Data: A single piece of data is generally composed of 2 bytes, with the high byte first and the low byte last.

The function codes used in this product are as follows:

Function Code (hexadecimal)	Function Description
03	Read input register
06	Write a single hold register

Register address:

Register type	Register Address	Implication	Bytes and data types
Input register	0X0000	Temperature value	2 bytes, signed integer, magnified 100 times
	0X0001	Humidity value	2bytes, unsigned integer, magnified 100 times
	0X0002	Dew point value	2 bytes, signed integer, magnified 100 times
	0X0003	Sensor status	2 bytes, unsigned integer,
	0X0004	Temperature value	2 bytes, signed integer, magnified 10 times
	0X0005	Humidity value	2 bytes, unsigned integer, magnified 10 times
	0X0006	Dew point value	2 bytes, signed integer, magnified 10 times
	0X0007	Sensor status	2 bytes, unsigned integer,

	0X0008	Temperature value	4 bytes, signed integer, magnified 1000 times
	0X0009		
	0X000A	Humidity value	4 bytes, unsigned integer, magnified 1000 times
	0X000B		
	0X000C	Dew point value	4 bytes, signed integer, magnified 1000 times
	0X000D		
	0X000E	Sensor status	4 bytes, unsigned integer,
	0X000F		
	0X0010	H ₂ O PPM _v	4 bytes, unsigned integer, magnified 1000 times
	0X0011		
	0X0012	H ₂ O PPM _w	4 bytes, unsigned integer, magnified 1000 times
	0X0013		
Hold register	0X0100	Device address	Two bytes, unsigned integer,
	0X0101	baud rate	Two bytes, see "Baud Rate Settings"
	0X0109	Sensor heating switch	Two bytes

<03 Function code - Read full data with a resolution of 2 decimal places>

Host query frame format(Hexadecimal):

Add	Function	Start Address (high priority)	Number of registers (H,L)	Check Code CRC-16)
0X01	0X03	0X00, 0X00	0X00, 0X04	0X44, 0X09

Transmitter response frame format (Hexadecimal)

Eg: Tem 26.27°C, Humidity 30.55%RH, Dew point 9.01°C

Add	Function	length	Data				check code (CRC-16)
0X01	0X03	0X08	Tem	Humidity	Dew point	Status	Low byte(before) High byte(after)
			0X0A 0X43	0X0B 0XEF	0X03 0X85	0X00, 0X00	0XD5,0X6A

The temperature and humidity calculation example is as follows:

Convert the hexadecimal into decimal and divide by 100 to get the corresponding temperature and humidity value.

Temperature: $0X0A43=2627/100=26.27^{\circ}\text{C}$

Humidity: $0X0BEF=3055/100=30.55\%RH$

Dew point temperature: $0X0385=901/100=9.01^{\circ}\text{C}$

When the temperature value is negative, the data is uploaded as a complement.

For example, if the temperature is =0XFF37, it is converted to decimal: -201, divided by 100, the temperature is -2.01°C

Status values: Analyzed by bit. bit0: indicates that the temperature sensor is faulty, bit1: indicates that the humidity sensor is faulty, and bit2 to bit15: indicates that the temperature sensor is retained.

<03 Function code - Read individual data>

Host query frame format (hexadecimal) :

Add	Function	Start Address (H,L)	Data Length (H,L)	Check Code (CRC-16)
0X01	0X03	Specified register address	0X00, 0X01	CRC-16

Slave (transmitter/probe) answer frame format (hexadecimal) :

Add	Function	Data Length	Data (H,L)	CRC-16(L, H)
0X01	0X03	0X02	2 bytes	2 bytes

Example : Reading the temperature value (33.21°C)

Down (upper computer /PLC) :

01 03 00 00 00 01 84 0A

Up (Sensor/transmitter) :

01 03 02 0C F9 7D 06

Example 2: Reading the Dew Point Value (15.86°C)

Down (upper computer /PLC) :

01 03 00 02 00 01 25 CA

Up (Sensor/transmitter) :

01 03 02 06 32 3A 31

<03 Function code - Read transmitter address>

Host query frame format:

Function	Register address (High priority)	Date length (High priority)	check code (CRC-16)
0X03	0X01, 0X00	0X00, 0X01	0X84, 0X27

Transmitter response frame format

Add	Function	length	Transmitter address		Check code (CRC-16)
			Address high	Address low	
0X00	0X03	0X02	0X00	0X01	0X44, 0X44

<06 Function code - Set address >

Format of the frame sent by the host (for example, 0X08=8) :

Add	Function	Register address (H,L)	Date length (H,L)	CRC-16 (L,H)
0X00	0X06	0X01, 0X00	0X00, 0X08	0X88, 0X21

The transmitter response frame is the same as the host sending frame:

Add	Function	Register address (H,L)	Date length (H,L)	CRC-16 (L,H)
0X00	0X06	0X01, 0X00	0X00, 0X08	0X88, 0X21

Instructions:

- * The mailing address ranges from 1 to 247
- * When the transmitter address is queried, the address code of the downlink packet is fixed at 0X00. When setting the transmitter address, the address code can be its own real address, or it can be 00 (to prevent forgetting the transmitter address, you can reset through the 00 address)
- * When using the 00 address code to reset the device address, ensure that there is only one transmitter on the bus.

<06 Function code - Set baud rate >

Host frame delivery format (for example, set the baud rate to 9600bps) :

Add	Function	Register address (H,L)	Date length (H,L)	CRC-16 (L,H)
0X00	0X06	0X01, 0X01	0X00, 0X04	0XD9, 0XE4

The transmitter response frame is the same as the host sending frame:

Add	Function	Register address (H,L)	Date length (H,L)	CRC-16 (L,H)
0X00	0X06	0X01, 0X01	0X00, 0X04	0XD9, 0XE4

Register value and baud rate comparison table:

Register value	Baud rate
=1	1200bps
=2	2400bps
=3	4800bps
=4	9600bps
=5	19200bps
=6	115200bps

Note: The change of the baud rate generally takes effect immediately. Note that the upper computer software needs to be reconnected with the new baud rate. If the change does not take effect, power it on again.

<06 Function code - Enable/Disable anti-condensation Settings >

Open Settings: 00 06 01 09 00 01 98 25

Off setting: 00 06 01 09 00 00 59 E5

Note:

- 1) During opening, the temperature of the probe will rise, which will affect the accuracy of the dew point value.
- 2) In order to protect the sensor, it will automatically turn off 10 minutes after opening (it can be closed by command within 10 minutes).

10. Maintenance and Troubleshooting

<Sensor cleaning>

The main body of the transmitter can be wiped and cleaned with a lint free damp cloth.

Do not immerse the transmitter in liquids, and do not use cleaning agents or solutions.

<Calibration of transmitters>

HG808 has been fully calibrated at the factory. The recommended calibration interval is 1 year. If there is reason to believe that the equipment is not within the accuracy specifications, a high-precision handheld dew point meter with a calibration certificate that can be used for on-site inspection should be used (the calibration certificate is valid). If on-site inspection shows that HG808 is not within its accuracy specifications, contact the supplier or your local agent to calibrate the HG808 transmitter.

<Troubleshooting>

◆ **Fault:**

After RS485 connection, there is no communication message.

◇ **Possible causes and solutions:**

It may be a wiring error or communication parameter error. Please carefully check the wiring and address, baud rate, register address, and other settings. In addition, incorrect power supply can also cause the transmitter to malfunction.

◆ **Fault:**

RS485 communication message has serious frame loss.

◇ **Possible causes and solutions:**

Perhaps the cable is too long or the RS485 converter has very strict requirements for level matching or poor anti-interference ability. Please try adding a 120 ohm balance resistor or replacing it with a reliable RS485 converter.

◆ Fault:

There is a communication message, and the upper computer cannot display data.

✧ Possible causes and solutions:

Some PLCs or DCS can only parse sensor data with a resolution of 0.1. HG808 provides two types of data with resolutions of 0.01 and 0.1. Please read the corresponding register address

◆ Fault:

Analog output error is relatively large.

✧ Possible causes and solutions:

The accuracy of analog signals also depends on the sampling error at the receiving end. Please check the working status of the receiving equipment. If it is confirmed that the error is not caused by the cable/receiver, please contact the manufacturer or dealer.

11. Testing Software Download link:

Software download link:

www.hkometer.com/download/

www.hengko.cn/download/

12. Note

1. The product should be fully connected to the receiving end such as PLC or computer before connecting to the power supply; Do not connect the sensor or receiver after power is applied;
2. The transmitter casing should be grounded to eliminate interference (recommended);
3. Do not touch sensor components or blow air;
4. The working power supply voltage should be used within the range;
5. Install the probe facing downwards;
6. The usage environment should not contain polluting gases (acidic);
7. The wind speed and pressure of the environment must be within the range of use;
8. The transmitter and probe should be installed away from sparks, flames, and flammable materials;
9. Other prohibited items for the use of transmitters.

Safety and warnings

- Before using the product, please read the user manual carefully. When operating according to the procedures detailed in this manual, the product is safe. Do not apply this product to measuring situations greater than the maximum value stated in the manual.
- Do not disassemble or replace any cables or electrical components that come with this product, as it may damage the transmitter.
- Before turning on the power, please confirm that all external wiring is correct. Any incorrect wiring or short circuit may cause damage to the transmitter.
- The transmitter must be maintained by the manufacturer or an approved agent.
- Some models of products have anti condensation function, which can improve the performance of sensors in high humidity and frozen environments, as well as perform sensor chemical cleaning. The start stop function is controlled by the user. To protect the sensor, it will automatically shut down after more than 10 minutes of activation.

Please read this user manual carefully before use.

The company reserves the right to interpret this user manual.

The appearance of this product is subject to the actual product.

Product technology or software upgrades are available without prior notice.



Contact Us

HENGKO Technology Co., Ltd.

Address:

Building 65, No. 43, Fukang Road, Pinghu Street,
Longgang District, Shenzhen, China

Contact number: 0086-0755-88823250

E-mail: ka@hengko.com

Website: www.hengkometer.com